

INSTALLATION PROCEDURE FOR PRESSURE TESTABLE JOINT CLOSURES WITH POUR FOAM WITH ERM

Materials & Equipment

MATERIALS:

1. Thermacor Pressure Testable Joint Closure Sleeve
2. Pour Foam, Components "A" & "B"
3. 3 Wooden Tongue Depressors (Per Kit)
4. 2 Frictional Weld Plugs (Per Kit)
5. ERM Jumper Cable (Per Kit)
6. 1 H.S. Patch & Sleeve

EQUIPMENT PROVIDED BY THERMACOR ON 30 DAY LOAN:

1. 110V Electric Power Control Unit w/ Adjustable Output (0-20 amps)
2. 3 Rubber Bands, each 4" Wide (per power unit requested)
3. Air Gauge Test Assembly
4. Ratchet Strap Tools

5. 1 Frictional Welding Drill Bit (per power unit requested)
6. Analog Ohmmeter

EQUIPMENT PROVIDED BY CONTRACTOR:

1. Hand Air Pump or Compressor
2. Clean Rags
3. Duct Tape
4. Hole Saw, 1" Hole Cutter
5. 5/8" Side Grinder
6. Safety Equipment as Prescribed by local Regulations
7. Tape Measure
8. Soap & Water Bottle
9. Propane Torch
10. Crimpers

Step 1.

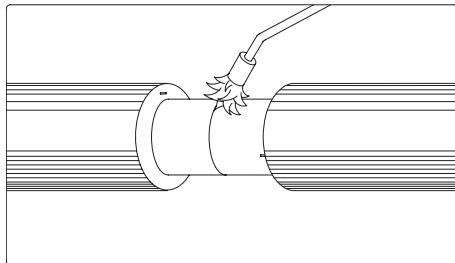

ONLY LABORERS TRAINED AND CERTIFIED BY THERMACOR ARE ALLOWED TO PERFORM THIS INSTALLATION. A Site foreman or inspector is required to inspect and log each joint on attached form. **Failure to provide this documentation will void Thermacor's warranty.**

Use a propane torch with a light billowy flame to dry the area out, regardless whether or not the area appears dry. Residual moisture may be present that is not readily seen.

Step 2.

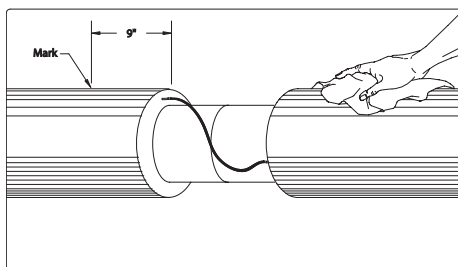

Following the ERM leak detection instructions, test the continuity of the pipe. Trim the bare copper wire so that it cannot make contact with the carrier pipe. Connect one end of the insulated jumper cable and crimp. Complete the connection to the second wire and crimp. Test the connection by following the ERM instructions. Make sure that the ERM jumper cable is **NOT** centered on the top of the joint, but placed to one side to prevent damaging the wire when drilling the air test hole. Clean HDPE jacket and wrap around sleeve with rag to remove any dust or dirt. Center the sleeve over the weld joint. Mark each end of PTJC on the HDPE jacket. On top of the jacket, make a mark 9" from the cutback on each side to locate pour holes.

Clean HDPE jacket and wrap around sleeve with rag to remove any dust or dirt. Using 80 grain emery cloth, roughen the entire fusion surface. Clean the surface after roughening using ethanol/ alcohol and a lint free cloth. Center the sleeve over the weld joint using the marks as a guide.

IMPORTANT: THE JOINT AND JOINT MATERIALS MUST BE KEPT DRY!!

Step 3.

Wrap the Pressure Testable Joint Closure (PTJC) Sleeve tightly over the insulated joint with the longitudinal seam at 12 O'Clock position. Joint should overlap 2 to 4 inches and shall be centered over the joint. Make sure the ends are square to each other at the overlap area. Hold in place with a 1" ratchet strap in the middle of the joint (**not shown**). (Note: If PTJC overlap is greater than 4" or less than 2", contact Thermacor for instructions.)

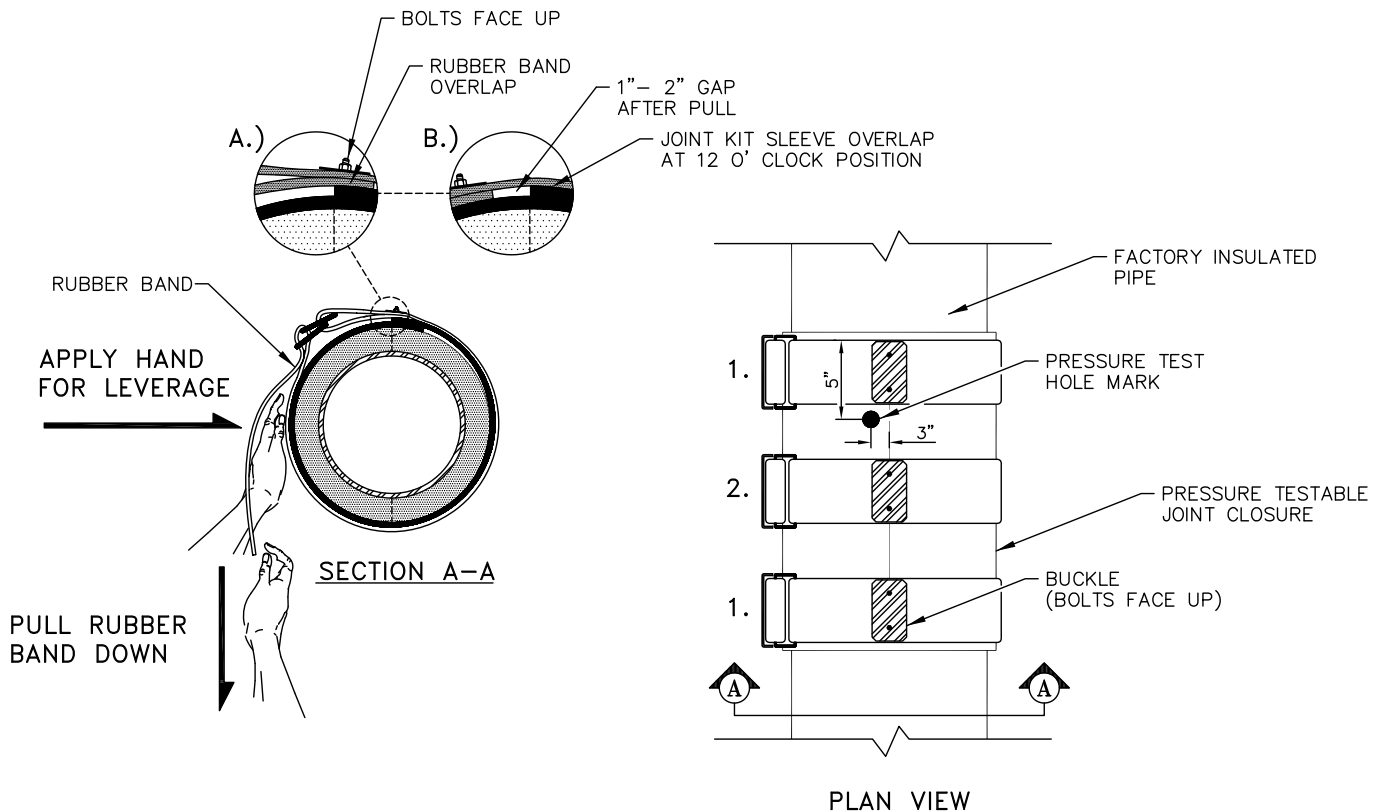

Tighten 1" ratchet strap to sleeve to ensure even pressure is maintained on fusion surfaces. No gaps should be visible. Stretch 2 of the 4" Rubber Bands, provided by Thermacor flush with the edge of the sleeve as shown. Rubber Bands need to be at the edge of the sleeve. Position the Rubber Bands such that the Rubber Band Overlap is approximately 1" past the Joint Overlap (A). BOLTS MUST BE FACING UP to avoid damaging the joint. The loose end of the rubber band is threaded from under to over through the buckle and the rubber band will be pulled tight in the same direction as the sleeve overlap.

Place one hand on the rubber band below the buckle as shown and pull the loose end of the rubber band to apply pressure to the seam of the PTJC sleeve. Continue pulling until a 1" - 2" gap appears between the Rubber Band Overlap and the Joint Overlap (B).

Follow the same procedure for the 2nd Rubber Band on the opposite end of the sleeve. REMOVE the ratchet strap and secure the 3rd Rubber Band following the same procedure..

Once all 3 Rubber Bands have been installed, mark the location for the pressure test hole approximately 5" from the end of sleeve and 3" from overlap as shown. Drill a 1" hole using the customer supplied 1" hole saw for the pressure test.

NOTE: 1" pressure test hole MUST be drilled prior to fusion to avoid pressure to develop inside the joint.

IMPORTANT: THE JOINT AND JOINT MATERIALS MUST BE KEPT DRY!!

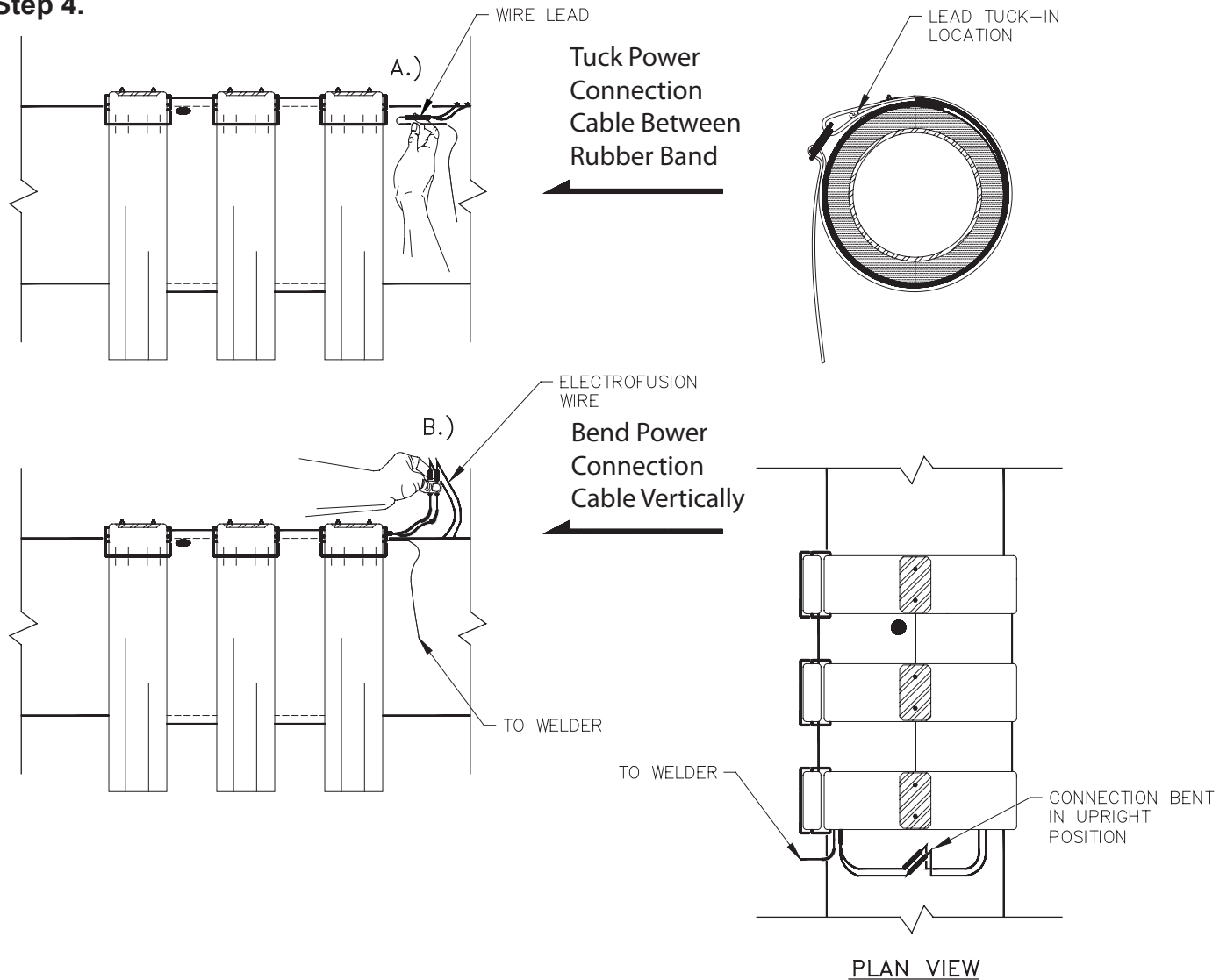
Step 4.

Connect the power connection cables from the welder to the Electro-Fusion wires.

Connect 110V single phase welding machine to a **DEDICATED POWER SOURCE**. Attach power cables extending from a 110V single phase welding machine to the Electro-Fusion wire. (Note: It does not matter which color power cable is connected to the Electro-Fusion wire). 2 white on one side, 2 black on the other side.

Bend and tuck the lower power connection cable between the rubber band overlap (5A), bend the power connection cable upwards as shown in Figure 5B. This will prevent contact between the Electro-Fusion wires and the outer jacket of the pipe.

Apply 12 +/-0.5 Amps electro-fusion wires attached to the sleeve. Maintain 12 Amps throughout the heating cycle. Check the Amp reading after 5 minutes of heating to ensure that the reading remains at 12 Amps. Do not exceed 12 Amps. See power chart for heating times. Heating times will vary. **NOTE: JOINT IS NOT COMPLETE UNTIL MELT IS VISIBLE EXTRUDING FROM ALL CIRCUMFERENTIAL SEAMS AND WIRE INDENTION IS SEEN IN CLOSURE.** As the heating cycle proceeds, the rubber bands exert constant pressure on the sleeve. The automatic timer is set for the correct heating time, shutting off the power at the end of the cycle. Allow power connection cables to cool for 5 minutes before disconnecting. Remove power cables and allow to cool for a minimum of 20 minutes or until the weld zone is the same temperature as the adjacent jacket. Do not remove the rubber bands until the joint has cooled!

IMPORTANT: THE JOINT AND JOINT MATERIALS MUST BE KEPT DRY!!

*Heating times increase with cold weather. Insulation blanket may be required around PTC during severe cold. Fusion complete when HDPE melt is seen oozing from all seams and wire indentation is seen (see pictures from submittal package).

POWER CHART

JACKET SIZE	AMPS	*MINUTES
5" TO 14"	12	20 – 30
16" TO 24"	12	25 – 35
26" TO 30"	12	30 – 40
30" AND UP	12	40 – 50

NOTE: Power requirement is 12 amps \pm 0.5

Step 5.

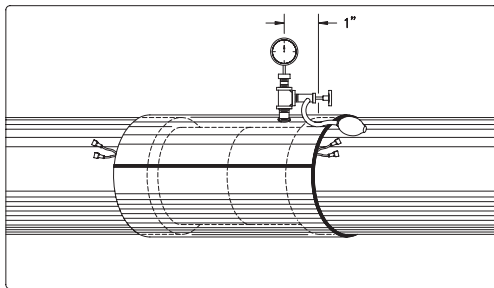

Push the Pressure Gauge and Valve Test Device into the Pressure Test hole. Using hand pump or other air supply obtain 5 psi pressure. Disconnect air supply and soap joint for "pin hole" leaks. Hold air pressure for 5 minutes. (Note: In rare cases air will escape down the interface between the foam and the jacket. This can be confirmed by soaping the end of the jacket interface).

Step 6.

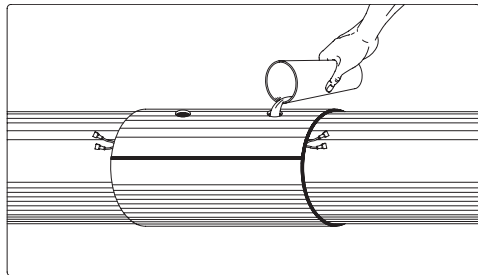

Remove test apparatus. Drill a second 1" hole 10" from the 9" mark. Mix required foam per Foam Kit Instructions and pour into 1" hole. Allow foam and gas (Air) to escape through holes, cover the holes with duct tape when the foam comes out of the holes. See Foam Kit Instructions for quantities, etc.

Step 7.

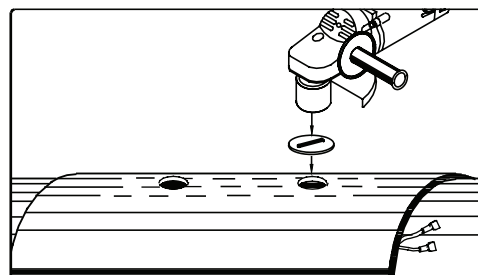

Clean any excess foam off the HDPE jacket. Using a chisel or other device, remove the foam from each hole to below the lip of the HDPE. Install drill bit provided by Thermacor into 5/8" side grinder. Only a 5/8" grinder can be used. Drills do not provide enough rotational velocity to properly fuse the plug to the sleeve. Fit the raised tongue of the white plug into the groove in the drill bit. Center the raised circle on the plug into the hole in the HDPE jacket.

IMPORTANT: THE JOINT AND JOINT MATERIALS MUST BE KEPT DRY!!

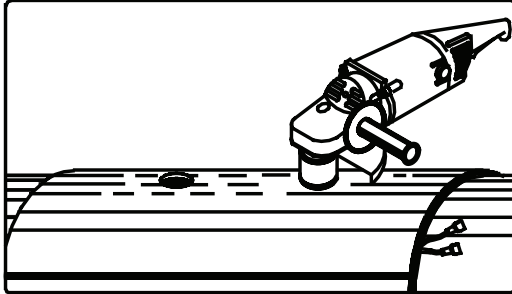
Step 8.

Apply firm downward pressure on the plug, then spin the plug at full speed until outside of drill bit touches HDPE jacket (approx. 13 seconds). Stop spinning the plug, but continue applying downward pressure. At the same time, tilt the grinder slightly, approximately 5 degrees, moving the grinder so that pressure is applied on all sides of the plug. Maintain the downward pressure for another 20 seconds.

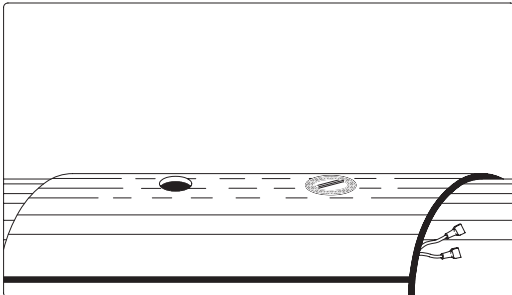
Step 9.

Visually inspect the plug after the fusing process. The edge of the clear plug should have turned black around the outer 1/2" if a good bond has been made. If the edges are not black, carefully drill the plug out (re-drill the existing hole) and repeat the process.

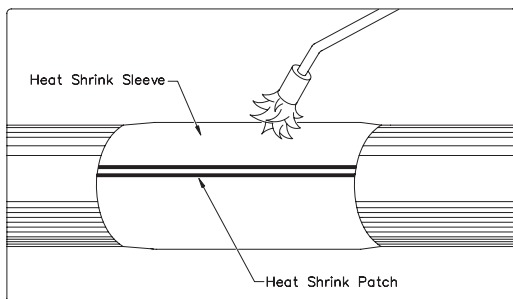
Step 10.

Crimp off the Electro-Fusion wires at the PTC sleeve. Using a soft billowy flame, heat the patch with a smooth brushing motion until it becomes soft and shiny. Remove heat and press the patch to the sleeve with a gloved hand to form a bond. Heat the rest of the heat shrink sleeve into place, starting at the bottom center of the sleeve and working up and out toward the ends. The mastic should be visible on both sides after the sleeve has cooled.

INSTALLER IS REQUIRED TO SIGN THEIR NAME AND DATE ON THE JOINT WITH A YELLOW PAINT PEN.

IMPORTANT: THE JOINT AND JOINT MATERIALS MUST BE KEPT DRY!!



HDPE PRESSURE TESTABLE JOINT CLOSURE INSTRUCTIONS

FKII
14.306

POUR FOAM- STANDARD FOAM W/ ERM

12.01.15

STANDARD POUR FOAM MIXING QUANTITIES

Pipe (in)	Pipe O.D. (in)	Jacket O.D. (in)	"A" Component (fl. oz)	"B" Component (fl. oz)
1/2	0.840	5.40	3.0	3.0
		6.68	5.0	5.0
3/4	1.050	5.40	3.0	3.0
		6.68	5.0	5.0
1	1.315	5.40	3.0	3.0
		6.68	5.0	5.0
1 1/4	1.660	5.40	3.0	3.0
		8.68	5.0	5.0
1 1/2	1.900	5.40	3.0	3.0
		6.68	4.0	4.0
2	2.375	6.68	4.0	4.0
		8.68	7.0	7.0
2 1/2	2.875	6.68	4.0	4.0
		8.68	7.0	7.0
3	3.500	8.68	7.0	7.0
		10.85	11.0	11.0
4	4.500	8.68	6.0	6.0
		10.85	10.0	10.0
6	6.625	10.85	8.0	8.0
		12.85	12.0	12.0
8	8.625	12.85	9.0	9.0
		14.12	12.0	12.0
10	10.750	14.12	9.0	9.0
		16.14	14.0	14.0
12	12.750	18.22	10.0	10.0
		18.22	17.0	17.0
14	14.000	18.22	14.0	14.0
		20.28	21.0	21.0
16	16.000	20.28	15.0	15.0
		22.25	23.0	23.0
18	18.000	22.25	17.0	17.0
20	20.000	24.38	19.0	19.0
24	24.000	28.25	22.0	22.0
		30.60	35.0	35.0
28	28.000	32.25	25.0	25.0
30	30.000	36.60	43.0	43.0

IMPORTANT: THE JOINT AND JOINT MATERIALS MUST BE KEPT DRY!!

INSTALLATION PROCEDURE FOR PRESSURE TESTABLE JOINT CLOSURES FOR THERMACOR HT- 406

Materials & Equipment

MATERIALS:

1. Thermacor Pressure Testable Joint Closure Sleeve
2. 3 Wooden Tongue Depressors (Per Kit)
3. 1 Frictional Weld Plug (Per Kit)
4. ERM Crimp (Per Kit)
5. High Temperature Sectional Foam
6. 1 H.S Sleeve & Patch

EQUIPMENT PROVIDED BY THERMACOR ON 30 DAY LOAN:

1. 110V Electric Power Control Unit w/ Adjustable Output (0-20 amps)
2. 3 Rubber Bands, each 4" Wide (per power unit requested)
3. Air Gauge Test Assembly
4. Ratchet Strap Tools
5. 1 Frictional Welding Drill Bit (per power unit requested)
6. Analog Ohmmeter

EQUIPMENT PROVIDED BY CONTRACTOR:

1. Hand Air Pump or Compressor
2. Clean Rags
3. Duct Tape
4. Hole Saw, 1" Hole Cutter
5. 5/8" Side Grinder
6. Safety Equipment as Prescribed by local Regulations
7. Tape Measure
8. Soap & Water Bottle
9. Propane Torch
10. Crimpers -Greenlee Recommended

Step 1.

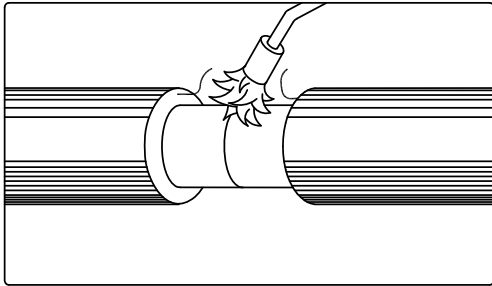

ONLY LABORERS TRAINED AND CERTIFIED BY THERMACOR ARE ALLOWED TO PERFORM THIS INSTALLATION. A Site foreman or inspector is required to inspect and log each joint on attached form. **Failure to provide this documentation will void Thermacor's warranty.**

- ① Use a propane torch with a light billowy flame to dry the area out, regardless whether or not the area appears dry. Residual moisture may be present that is not readily seen.

Step 2.

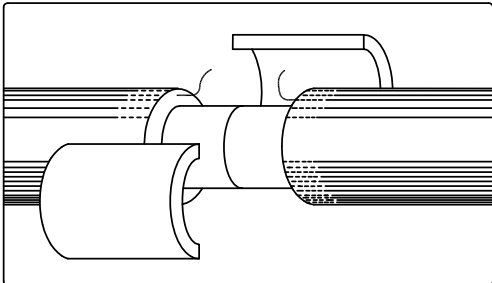

- ② Insulate the joint using high temperature sectional foam. Measure distance between factory ends and cut insulation to fit, making sure the insulation fits between factory insulation tightly, without gaps. Tape into place. See following illustration for orientation of sectional foam.

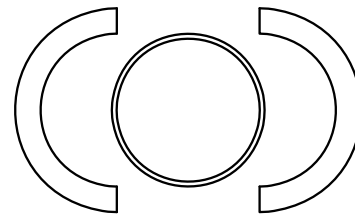

SECTIONAL FOAM ORIENTATION

ALL FIELD MODIFICATIONS MUST BE APPROVED IN WRITING!

In the event that a field modification is required and the diffusion barrier needs to be trimmed back, use a putty knife to trim the protective HDPE and Aluminum diffusion barrier back so that normal fusion can occur on the base HDPE layer. Take care not to cut into the base HDPE layer. **DO NOT ATTEMPT TO FUSE (OR HEAT SHRINK) THE JOINT CLOSURE TO THE PROTECTIVE HDPE.** Trim the protective HDPE approximately 6" back from the end of insulation and perform the normal joint kit insulation.

IMPORTANT: THE JOINT AND JOINT MATERIALS MUST BE KEPT DRY!!