

FIBER-THERM

FRP PIPING SYSTEM



FIBER-THERM

THERMACOR'S FIBER-THERM is a factory-fabricated, pre-insulated piping system for below ground distribution of chilled water, heating water, domestic hot water, process fluids, and condensate return. The system is designed with Fiberglass Reinforced Plastic (FRP) pipe, closed cell polyurethane foam insulation, and High Density Polyethylene (HDPE) jacket.

Carrier Pipe

- FRP - Fiberglass Reinforced Plastic
- ASTM D2996
- MIL-28584B

Polyurethane Insulation

- Density $> 2.0 \text{ lbs/ft}^3$
- "K" Factor $\leq 0.16 @ 75^\circ\text{F}$
- Compressive Strength $> 30 \text{ psi}$
- Closed Cell Content $\geq 90\% @ 75^\circ\text{F}$

Jacket

- High Density Polyethylene (HDPE)

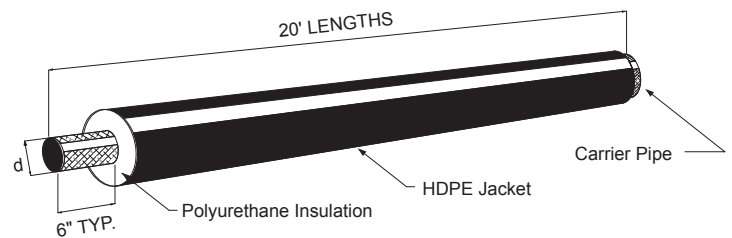

SPECIFICATION GUIDE *

GENERAL

All underground piping materials transporting chilled water, heating water, domestic hot water, process fluids, and condensate return shall be **FIBER-THERM** as manufactured by **THERMACOR PROCESS INC.** All straight pipe, fittings, insulating materials, and technical support shall be provided by the manufacturer.

SERVICE PIPE

The carrier or service pipe shall be FRP, fiberglass reinforced epoxy pipe. Pipe and fittings are capable of operating from -40 to 250°F at 140 psi. Piping is provided as plain-end by plain-end with a coupling for adhesive joining for 2" thru 6" and integral bell and spigot for 8" thru 16". All FRP pipe and fittings shall be joined with a matched taper epoxy adhesive joint cured by an external heat source.

INSULATION

Insulation of the service pipe shall be rigid polyurethane foam with a minimum 2.0 lbs/ft³ density, 90% minimum closed cell content, minimum and a "K" factor not higher than .16 at 75°F per ASTM C518. The polyurethane foam shall be CFC-free. The polyurethane foam shall completely fill the annular space between the service pipe and jacket, and shall be bonded to both. Insulation shall be provided to the minimum insulation thickness specified.

JACKET

The outer protective jacket shall be extruded, black, high density polyethylene (HDPE). No FRP, HDUP, or tape jacket allowed.

FITTINGS

Fittings shall be FRP, filament wound and joined with Thermosetting epoxy adhesive and cured with an external heat source. Fittings are not insulated and are poured in concrete thrust blocks at all changes of direction. Flanges are filament wound matching ANSI B16.1 for 150# flanges. *Thrust block design and sizing is the responsibility of the design engineer.*

FIELD JOINTS

Service pipe shall be hydrostatically tested as per the Engineer's specification with a Manufacturer's recommendation of 1.5 times the specified pressure of the system. Joints between pipe sections are not insulated on FRP systems. *At the Engineer's option*, straight field joints may be covered by a split or oversized sleeve and sealed with a heat shrink sleeve to prevent the ingress of moisture or debris. All jacketing materials shall be furnished by THERMACOR.

INSTALLATION

Installation of the piping system shall be in accordance with the manufacturer's instructions. Factory trained field technicians shall be provided for critical periods of installation, unloading, field joint instruction, and testing.

* For alternate specifications, please contact THERMACOR.

THERMACOR PROCESS INC. Your Authorized THERMACOR Representative Is:

1670 Hicks Field Road East
Fort Worth, Texas 76179-5248
P.O. Box 79670

Phone (817) 847-7300
Fax (817) 847-7222
www.thermacor.com

The information contained in this document is subject to change without notice. THERMACOR PROCESS INC. believes the information contained herein to be reliable, but makes no representations as to its accuracy or completeness.

THERMACOR PROCESS INC. sole and exclusive warranty is as stated in the Standard Terms and Conditions of Sale for these products. In no event will THERMACOR PROCESS INC. be liable for any direct, indirect, or consequential damage.



FIBER-THERM

Specification Guide

FISG
9.101

STANDARD SPECIFICATION

8.10.11

Pre-insulated FRP Piping Systems suitable for Chilled Water, Heating Water, Domestic Hot Water, Process Fluids, and Condensate Return.

Part 1 - General

1.1 Pre-insulated Piping - Furnish a complete system of factory pre-insulated Fiberglass Reinforced Plastic (FRP) piping for the specified service. All pre-insulated pipe, fittings, insulating materials, and technical support shall be provided by the Pre-insulated Piping System manufacturer.

1.2 The system shall be **FIBER-THERM** manufactured by **Thermacor Process Inc.** of Fort Worth, Texas.

Part 2 - Products

2.1 Carrier pipe shall be FRP, fiberglass reinforced epoxy. Pipe and fittings are capable of operating from -40 to 250°F at 140 psi. Piping is provided as plain-end by plain-end with an FRP coupling for adhesive joining for 2" thru 6" and integrated bell by spigot for 8" thru 16". All FRP pipe and fittings shall be joined with a matched taper epoxy adhesive joint cured by an external heat source.

2.2 Insulation shall be rigid polyurethane foam either spray applied or injected with one shot into the annular space between carrier pipe and jacket, and shall be bonded to both. Insulation shall be rigid, minimum 90% closed cell polyurethane with a minimum 2.0 lbs per cubic foot density, compressive strength of 30 psi @ 75°F, and coefficient of thermal conductivity (K-Factor) of not higher than 0.16 @ 75°F per ASTM C-518. Maximum operating temperature of urethane shall not exceed 250°F. Insulation thickness shall be specified by calling out appropriate carrier pipe and jacket size combinations as listed on drawing FISG 9.103.

2.3 Jacketing material shall be extruded, black, high density polyethylene (HDPE), having a wall thickness not less than 100 mils for jacket sizes less than or equal to 12", 125 mils for jacket sizes between 12" and 24", and 150 mils for jacket greater than 24". No tape jacket allowed. The inner surface of the HDPE jacket shall be oxidized by means of corona treatment, flame treatment (patent pending), or other approved methods. This will ensure a secure bond between the jacket and foam insulation preventing any ingress of water at the jacket/ foam interface.

2.4 Straight run joints are not insulated on FRP systems. (*At the Engineer's option, straight field joints may be covered by a split or oversized sleeve and sealed with heat shrink tape to prevent the ingress of moisture or debris.*)

2.5 Fittings shall be FRP, filament wound and joined with Thermosetting epoxy adhesive and cured with an external heat source. Fittings are not insulated and are poured in concrete thrust blocks at all changes of direction. Flanges are filament wound matching ANSI B16.1 for 150 lb. flanges. *Thrust block design and sizing is the responsibility of the design engineer.*

Part 3 - Execution

3.1 Underground systems shall be buried in a trench of not less than two feet deeper than the top of the pipe and not less than eighteen inches wider than the combined O.D. of all piping systems. A minimum thickness of 24 inches of compacted backfill over the top of the pipe will meet H-20 highway loading.

3.2 Trench bottom shall have a minimum of 6" of sand, pea gravel, or specified backfill material, as approved by the engineer, as a cushion for the piping. Pipe and fittings shall be laid sequentially, field cutting the pipe as necessary per the manufacturer's installation instructions. At least the center 75% of each section of pre-insulated pipe shall be covered (approximately one foot of cover per 100 psi of test pressure) with select backfill material. All field shall be suitably thrust blocked before attempting any pressure tests of the system.

3.3 A hydrostatic pressure test of the carrier pipe shall be performed per the engineer's specification with a factory recommendation of one and one-half times the normal system operating pressure for not less than two hours. Care shall be taken to insure all trapped air is removed from the system prior to the test. *Appropriate safety precautions shall be taken to guard against possible injury to personnel in the event of a failure.*

(Continued)



FIBER-THERM

Specification Guide

STANDARD SPECIFICATION

FISG

9.102

3.14.07

3.4 Field service, if required by project specifications, will be provided by a certified manufacturer's representative or company field service technician. The technician will be available at the job to check unloading, storing, and handling of pipe, joint installation, pressure testing, and backfilling techniques. This service will be added into the cost as part of the project technical services required by the pre-insulated pipe manufacturer.

Carrier Pipe:

- Fiberglass Reinforced Plastic (FRP)
- FRP pipe is filament wound using glass fibers and epoxy resin with a nominal 0.02" reinforced liner.
- Note: 1" & 1-1/2" are long lead time items.

Jacketing Material:

High Density Polyethylene (HDPE)

Insulation:

Polyurethane Foam

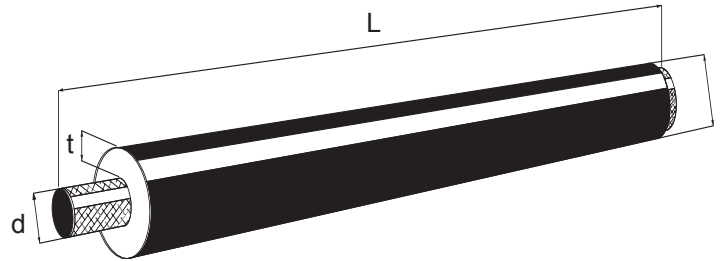

Pipe Size	Jacket Size	Standard Length L	Insulation Thickness t	External Diameter D	Weight Per Foot (lbs.)
1"	5.4"	10'	1.94"	5.40"	1.9
1-1/2"	5.4"	10'	1.65"	5.40"	2.2
2"	5.4"	20'	1.41"	5.40"	2.2
3"	6.7"	20'	1.50"	6.68"	3.0
4"	8.7"	20'	2.00"	8.68"	4.4
6"	10.9"	20'	2.04"	10.85"	6.4
8"	12.9"	20'	1.99"	12.85"	8.7
10"	14.1"	20'	1.56"	14.12"	10.6
12"	16.1"	20'	1.57"	16.14"	12.8

* Other pipe and jacket size combinations are available.

** Insulation thickness is calculated using minimum wall thickness. Actual wall thickness may be greater than stated, thereby minimally decreasing actual foam thickness.



FIBER-THERM

Installation Manual

FBIM
9.201

GENERAL INSTALLATION INSTRUCTIONS

3.14.07

INSTALLATION INSTRUCTIONS

UNLOADING & HANDLING

Lift joints from trucks. DO NOT DROP SHARP OR HEAVY OBJECTS ON INSULATED UNITS. DO NOT use chains or other devices which might puncture insulation jacket.

STORAGE

Pipe is stockpiled off the ground. Do not exceed a stacking height of 6'. Prevent dirt and debris from entering pipe. Fittings, joining materials, etc. must be stored indoors to protect them from freezing, overheating, moisture, or loss.

LAYING OF PIPE UNITS – TRENCHING

All sharp rocks, roots, and other abrasive material must be removed from the trench. The trench bed should be 6" of sand or backfill as specified by the engineer, providing a smooth and uniform stabilizing surface (sandbags may be used as a means to keep the pipe off the ground until backfilling is started). The trench width should provide a minimum of 6" from trench wall to jacket O.D. and a minimum of 6" between pipe units. Trench depths will be indicated on the contract drawing and in line with good construction practices. Trench depth should allow for a minimum cover of 24" on top of the insulated unit.

FIELD JOINING METHODS

For all cases, follow the pipe manufacturer's instructions. The following is meant as a general guideline for Fiber-Therm 2000 FRP 2" thru 6" installation only. Insure that all taper and bonding surfaces are clean and dry. All pipe sockets, pipe ends, and fitting sockets should be sanded using 40 to 120 grit sandpaper. Sanding should remove the exterior gloss and resultant pipe should show a dull finish. Use a clean, dry cloth to remove all glass particles from surfaces to be bonded. Do not touch cleaned surfaces with hands or any other material that would deposit oil and impair proper joint adhesion. Protect the bonding surfaces from moisture, do not install in inclement weather, or at a minimum, protect the work area with tenting. If surfaces are moist, warm with heat blanket or heat gun and resand. If surfaces are oily or greasy, they should be resanded. All bonding surfaces must be sanded within two hours of assembly. NOTE: Special instructions are required for 8" and larger Fibertherm 2000 FRP.

Mix adhesive according to directions taking careful notice of the working life. Please review adhesive kit instructions prior to mixing. As a general guideline: Do NOT split kits. Mix all hardeners with adhesive. Thoroughly mix until color is uniform.

APPROXIMATE WORKING TIME

Adhesive Temperature	70°F / 21°C	80°F / 27°C	100°F / 38°C
Pot Life	30 min.	20 min.	8 min.

NUMBER OF BONDS PER KIT

Kit Size	2"	3"	4"	6"	8" thru 16"
3 oz.	4	3	2	1	see pipe literature
5 oz.	10	6	4	2	literature

Apply a thin, uniform coating of adhesive to the spigot, spigot end, and bell bonding surfaces. Enough adhesive should be used to form a bead surrounding the pipe when insertion has been completed. Only enough adhesive to wet the surfaces is needed. More is not better.

The spigot end should be inserted without rotation until contact of the matching taper in the bell is felt. DO NOT TWIST THE PIPE DURING INSERTION. After initial insertion of 8" pipe and larger, a come-a-long should be used to insure that the proper insertion depth has been obtained. Take careful notice to protect pipe with padding where the come-a-long is fastened. Support the winch on a wooden bridge across the joint so the winch can be left snug while the heating blanket cures the adhesive. Tap a wooden block held against the next bell end of the pipe to be sure the spigot end has been fully inserted. NEVER USE A HAMMER DIRECTLY ON THE FRP PIPE OR FITTING.

Place the thermostat end of heating blanket against the assembled joint (thermostat facing out). Wrap the remainder of the blanket around the joint so that any overlap will cover the thermostat. Tie the blanket in place with a nonconducting tie. Apply electric power to the blanket, simultaneously marking start time on the jacket. Insure that the blanket heats up and is working. A minimum 30-minute cure time for pipe joints and a 45-minute cure time for fitting joints is required. DO NOT MOVE pipe joint until pipe has cooled to touch for at least two hours.

FIELD ALTERATIONS

Pipe will be cut in the field, based on the appropriate field measurements for fittings and/ or making manhole or wall entries. If special lengths are required, measure distance needed for field alteration and cut through unit with hack saw or abrasive wheel. Using factory insulated pipe as guide, cut back insulation. Apply end seals to the clean, dry, exposed insulation surface. Check the squareness of cut with carpenter's square. Remove glassy resin material to bare fiberglass by sanding outer surface. Prepare pipe for joining as described in Field Joining Methods.

BACKFILL INITIAL

After pipe is installed, specified backfill shall be tamped around the conduit in 6" layers to insure proper compaction. One foot on either side of each joint and fitting shall be left bare for visual inspection during testing.

TESTING

Sufficient backfill must be placed on pipe and thrust blocks poured and cured, prior to testing. Bleed all air from lines to eliminate possible incorrect readings. The hydrostatic pressure test shall be performed per the engineer's specification with a factory recommendation of one and one-half times the normal operating pressure for not less than two hours. Inspect all fittings, valves, and couplings at this time. **NEVER TEST WITH AIR!** *Appropriate safety precautions shall be taken to guard against possible injury to personnel in the event of a failure.*

BACKFILL FINAL

Before backfilling is started, the trench should be cleaned of any trench wall cave-ins and general trash. Backfilling should be done with sand or other engineer-approved material 6" below the casing to 1' above. Engineer-approved backfill may be used to fill the rest of the trench. This material should be free of rocks, roots, large clods, or anything that could cause damage to the jacket. Jacket should have a minimum of 2' cover.

WHEELED OR TRACKED VEHICLES SHALL NOT BE USED FOR TAMPING!

THRUST BLOCK INSTALLATION

The engineer who designs the system has the responsibility for designing and sizing the thrust blocks. Knowledge of site soil conditions is essential for proper design. Thermacor will not accept or assume responsibility for thrust blocks, and intends to provide basic data only.

WHY THRUST BLOCKS?

A Fiber-Therm system must include thrust blocks to prevent any pipe movement from temperature changes. To prevent separation, thrust blocks must be located at:

1. All major changes in direction; i.e., tees and elbows (both horizontal and vertical).
2. All changes in size.
3. All terminal ends.
4. All Valves, so as to support the body weight and prevent excessive torque on pipe connections.
5. **IMPORTANT:** Any connecting metallic pipe must be anchored at the point of connection to the FRP pipe to prevent excessive stresses from being transferred to the FRP pipe.

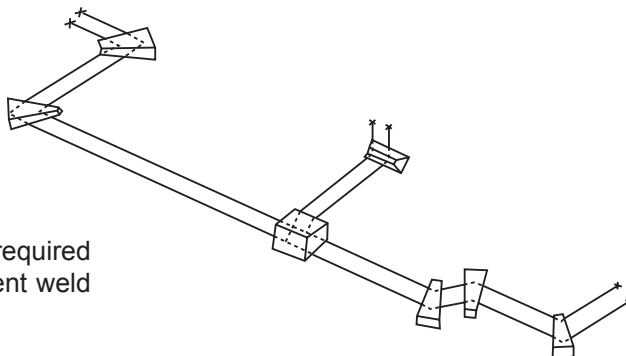

NOTE: Thrust blocks are required with gasket pipe and solvent weld fittings.

INSTALLATION

As thrust blocks are an essential part of the system, they should be poured before hydrostatic testing. Temporary thrust blocking may be used with extreme caution if absolutely necessary. The system must be retested after the permanent thrust blocks are poured and cured to verify that the thrust blocks will resist the thrust.

DESIGN

The design of the thrust blocks depends on test pressure, size, number of pipes, soil conditions, and types of fittings involved. Three conditions must be met for the thrust blocks to function properly.

1. The bearing area must be adequate to resist the pressure force.
2. The bearing surface must rest directly against undisturbed soil.
3. The face of the block bearing surface in the soil must be perpendicular to the resultant direction of thrust.

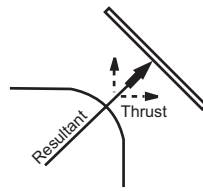

90° ELBOW

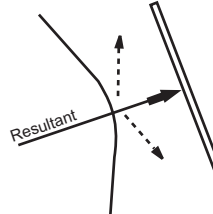

45° ELBOW

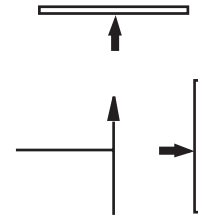

REDUCING TEE

If the thrust blocks have not been designed by the engineer, they must be sized by the following procedure:

Example: Design a thrust block to resist the horizontal thrust of two 4" hot water lines (supply and return) at a 90° elbow. The operating temperature of the system is 220° F and the soil is soft clay.

TABLE 1 POUNDS OF THRUST AT FITTING (FORCES ARE ASSUMED THE SAME THRU 250°F)				TABLE 2 SAFE BEARING LOADS	
PIPE SIZE	TEE	90°	45°	SOIL	LB. PER SQ. FT.
2"	2,300	3,250	1,760	Muck, Peat	0
3"	3,300	4,670	2,520	Soft Clay	1,000
4"	5,600	7,900	4,270	Sand	2,000
6"	8,300	11,700	6,350	Sand & Gravel	3,000
8"	12,000	17,000	9,200	Sand & Gravel cemented with clay	4,000
10"	15,000	21,200	11,500	Hard Shale	10,000
12"	17,900	25,400	13,700		

STEP 1

FINDING THRUST:

From Table 1, the resultant thrust of a 4" x 90° elbow is 7900 lbs.

7900 lbs. x 2 = 15800 lbs. thrust for two elbows.

STEP 2 FINDING BEARING AREA OF BLOCK:

From Table 2, soft clay has a bearing strength of 1000 lbs./ sq. ft. therefore:

$$\frac{15800 \text{ lbs.}}{1000 \text{ lbs./ sq. ft.}} = 15.8 \text{ sq. ft. bearing area required}$$

or a block face of 8' x 2' (16 sq. ft.) is adequate.

THRUST BLOCK TYPES

Examples of thrust blocks for normal fittings are illustrated.

For vertical risers the trench bottom must be undercut, and the entire trench bottom should be covered with concrete. The thrust blocks must bear against firm, stable soil.

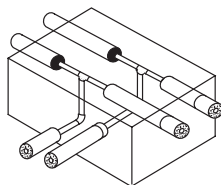

FIGURE II

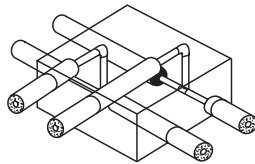

FIGURE I

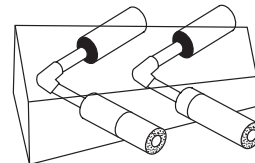

FIGURE III

CONSTRUCTION

Thrust blocks are made of concrete.

An acceptable concrete is 1 part Portland cement, 2 parts washed sand, and 3 parts washed gravel with enough water for a relatively dry mix. The dry mix is easier to shape and offers higher strength.

The concrete should be worked thoroughly around the elbows for maximum surface contact. Make sure the entire area between the fittings and the trench wall is filled with concrete and free of voids.

The blocks should be shaped with the designed bearing area against the trench wall. Smaller blocks should be shaped by hand. Larger blocks require simple forms.

The trench should be undercut under the pipes at least six inches to give added thrust resistance and to provide adequate concrete around the fittings. Six inches of concrete should be over the top of the pipe.

The center of the thrust blocks bearing surface should coincide with the horizontal center line of the pipes. (See figures I and II).

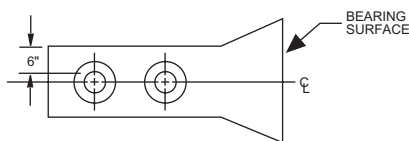

FIGURE I

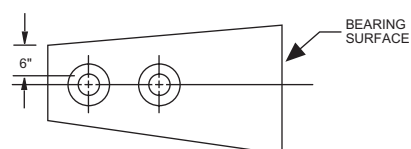

FIGURE II

UNSTABLE SOIL

If the soil is unstable in the area of a thrust block, it will be necessary for the engineer to make special provisions. This is considered a civil engineering matter and a project civil engineer should be consulted for professional advice.

VALVE BLOCKS

Blocks must be poured beneath valves with sufficient steel for valve connections. This supports the valve weight and prevents any torque or twisting action caused by opening and closing the valve.

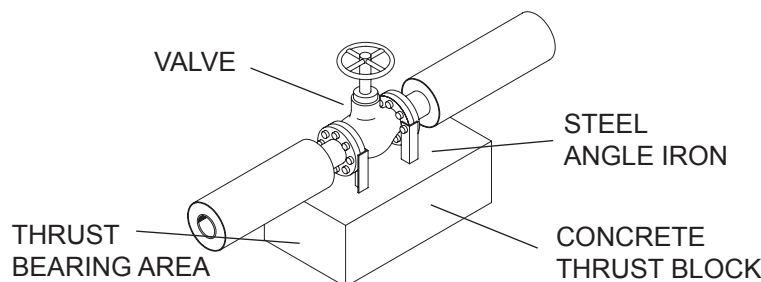

SHIPPING & HANDLING INSTRUCTIONS

HANDLE COATED PIPE WITH EXTRA CARE! THIS PIPE CAN DAMAGE WHEN HANDLED, MOVED, OR STORED IMPROPERLY!

UPON RECEIPT OF MATERIALS

Make an overall inspection of the load, checking all bands and braces to see if they are intact. Also, check the load for shifting. If the load has shifted, or if the braces and bands are broken, examine each pipe for damage. HAVE THE TRUCK DRIVER MAKE AN ITEMIZED NOTATION OF ANY DAMAGE ON THE DELIVERY RECEIPT AND HAVE IT SIGNED BY THE DRIVER.

CHECK PACKING LIST

Compare materials received with those listed on the packing list. Count all pipe and boxes. NOTE ANY SHORTAGES ON DRIVER'S DELIVERY RECEIPT.

CHECK BOXES

Open all boxes and inspect for damages, shortages, and correct size. REPORT ANY DISCREPANCIES WITHIN 30 DAYS AFTER RECEIPT.

CLAIMS FOR DAMAGES

Claims for damages in transit or lost goods must be made within 30 days. The filing of any claim is the Purchaser's Responsibility. Thermacor will file any claim on Purchaser's behalf upon receipt of the following:

1. Written authority to file such a claim.
2. Written notice of loss or damage (signed and noted Bill of Lading) by truck driver or carrier freight agent.

UNLOADING PIPE

Pipe may be unloaded by hand or with fork lifts*, cherry pickers, or cranes. DO NOT HOOK pipe ends. Minimum 4" wide straps or slings should be used.

*Fork Lift – When using Fork Lift, wide tines or a large surface covering the fork tines must be used to prevent coating damage. Fork Lift must be able to handle the weight of the insulated pipe length.

PIPE STOCKPILING

Pipe should be stored on level ground, elevated to be as dry as possible, and in such a way that the pipe ends do not lie in water or on the ground. To prevent deformation of the jacket and insulation due to the weight of the pipe, place a series of supports (3 for 20' or 5 for 40') of ample size generally constructed from 2" x 4"s under the pipe as shown below. Supports should increase in width as weight load increases so that the top supports of a fully loaded stockpile should be approximately 10" wide, gradually increasing to the bottom level, approximately 18" wide. Pipe can be pyramided (within reasonable and safe limits) approximately 6' high after a properly braced or chocked base is formed. Pipe stored outside for long periods of time can be covered with blue mesh tarpaulin (plywood can also be used). **Do not prevent airflow as jacket can be deformed from heat buildup.**

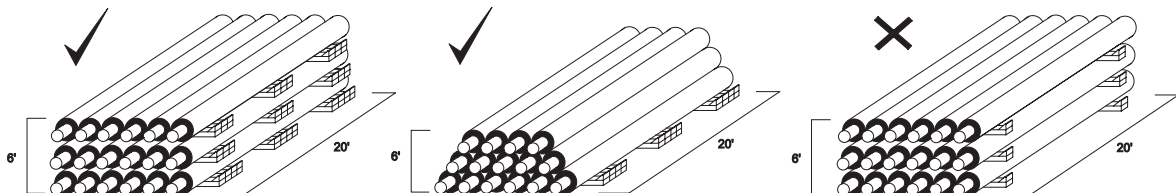

BE VERY CAREFUL NOT TO DROP THE PIPE!

NOTE: Thermacor does not approve of the practice of installing pipe and fittings, and backfilling the pipe before testing. Thermacor will not allow or pay claims for charges which arise in locating and digging up leaks regardless of cause.